



uPVC Windows & Doors Product Manual

Economically Priced | Reliable Quality

www.greentechupvc.com

ABOUT US

GreenTech uPVC India Pvt. Ltd., based at Hyderabad have been established in 2013. The young team of management personals have vast experience in the manufacturing of uPVC Windows. The team has more than 15 years of professional experience with various multi-national companies. Having experience in plastic industry for more than a decade we have more confident to serve our customers in better manner.

We GreenTech uPVC deals with the following product in India.

- uPVC Windows & Doors Profile.
- uPVC Windows & Doors Fabrication Machines.

In addition we provide support for uPVC Windows and Doors fabrication.



Greentech Window VISION

Greentech's vision, "We create human-friendly, eco-conscious living spaces," informs all our strategies for realizing eco-conscious, energy-efficient, and human-friendly customer value.

Our market-leading, eco-friendly products and advanced technology allow the design of aesthetically-pleasing and comfortable interiors. In the spirit of innovative enthusiasm, we make it our top priority to 'lead the market' and create flourishing, greener, user-friendly living spaces.

Greentech always puts customer health, happiness and satisfaction first when creating its unique living spaces.

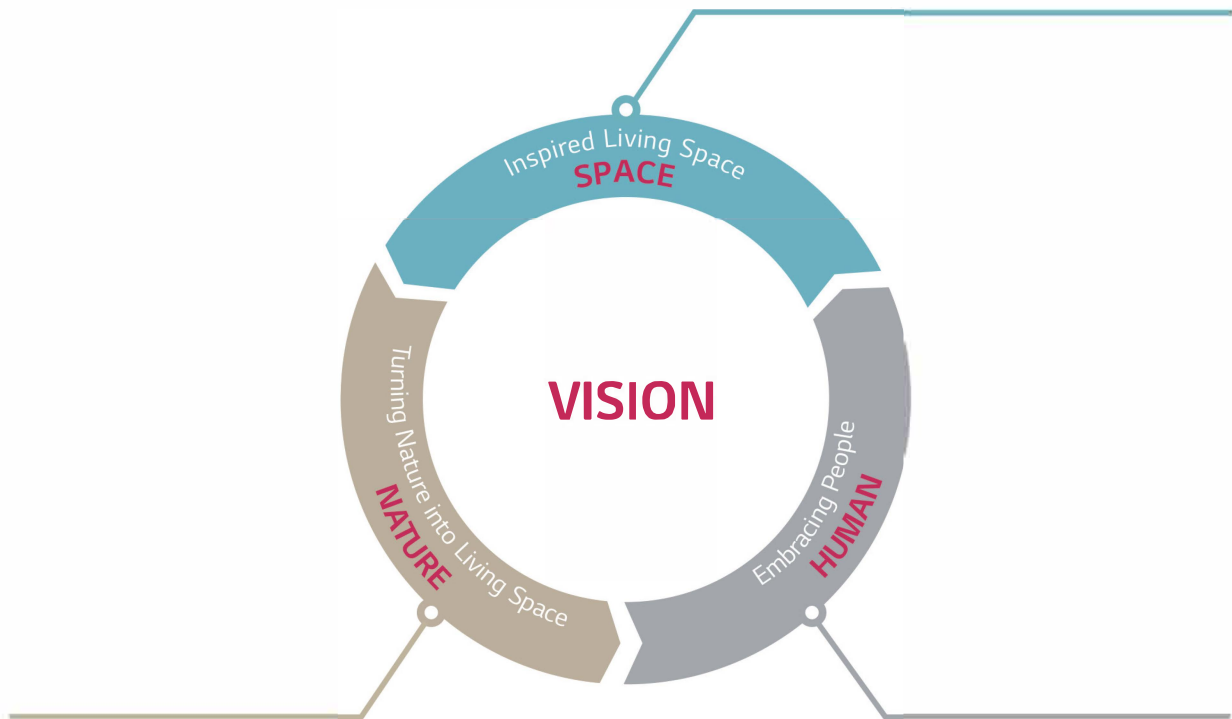

With our eco-friendly materials and energy efficiency gains, we pursue spaces congruent with nature and the quality of life for our customers.

Eco-Friendly

Shift to eco-friendly materials through the pursuance of diversity in material use

Energy Saving

Deliver systems and solutions that maximize energy efficiency

While simultaneously setting tomorrow's trends, our aesthetically-pleasing, "feel good" designs greatly enhance our customer's quality of life.

Human-Friendly

Set more reliable relationship-oriented customer contact points



European style casement window

CASEMENT WINDOW



- Option I**
- In ward opening type
 - Out ward opening type



Application | For residential APT **Glass** | 5~30mm
K/ value | Below 2.45 (Double glazing) **Number of chamber** | 3 chamber

Slim design

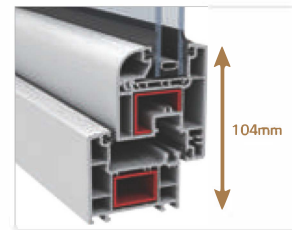

Round GB

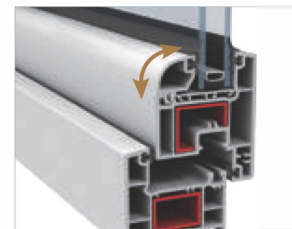

High strength structure

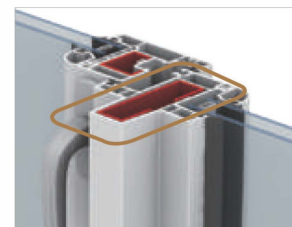

FEATURES

- Slimline Frame
 - Designed to maximize sunlight, enhance views
- Various glass thickness available
 - Adoption of maximum 30mm glass diminished the external noise and enhanced insulation
- Trendy design
 - Feel soft with decorative round glazing bead
- High strength structure (Option)
 - Extension of reinforcement areas in profile (reinforcement-integrated mullion and transom)

* The more chambers, the insulation performance is better.
 * Some product's handle & locking system can be an option.

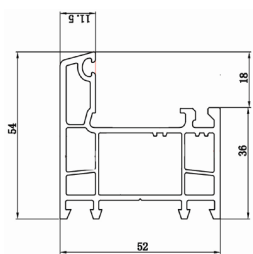
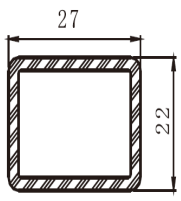
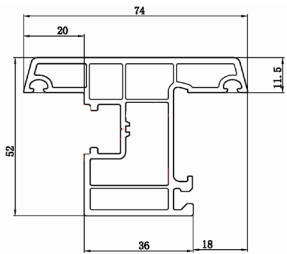
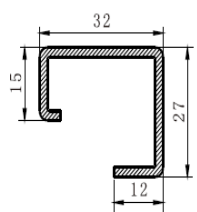
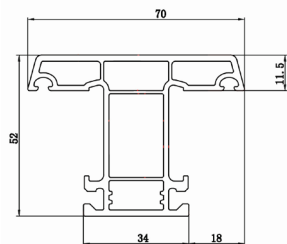
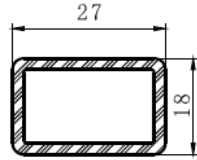
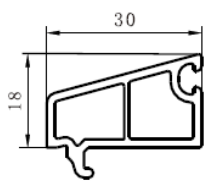
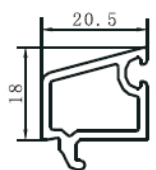
Profile Code	Name & Details	Profile Sectional View	Pack Qty	Wt/Mtr	Steel
CF-52-GT	Casement Outer Frame		6 Pcs with Gasket	0.880 Kg/Mtr	
CSO-52-GT	Casement Window Sash (Outward)		6 Pcs with Gasket	1.070 Kg/Mtr	
CFTM-52-GT	T-Mullion		6 Pcs with Gasket	0.950 Kg/Mtr	
GB-30-GT	Casement Single Glazing Bead (4-6mm)		20 Pcs with Gasket	0.304 Kg/Mtr	
GB-20-GT	Casement Double Glazing Bead (19-21mm)		20 Pcs with Gasket	0.234 Kg/Mtr	

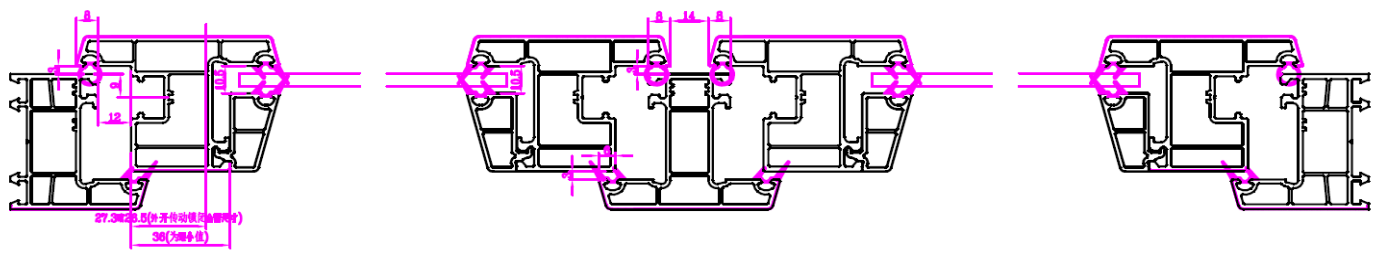

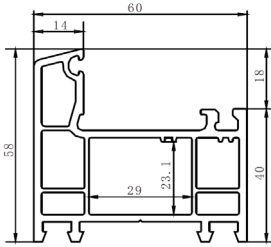
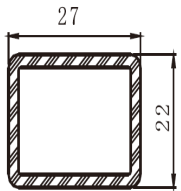
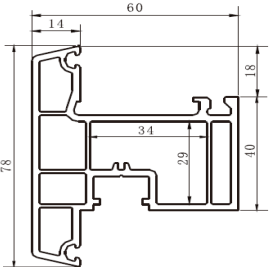
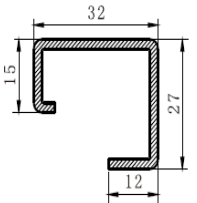
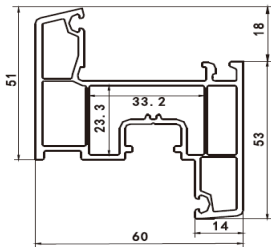
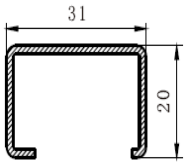
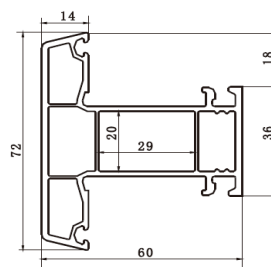
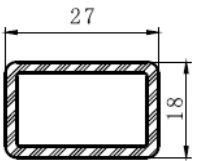
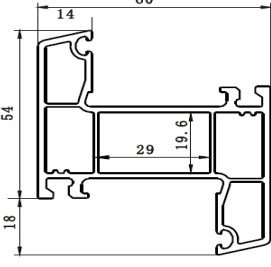
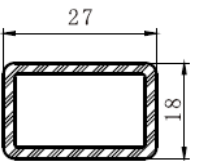
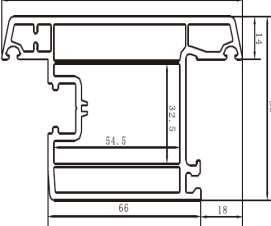
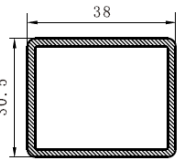
Profile Code	Name & Details	Profile Sectional View	Pack Qty	Wt/Mtr	Steel
CF-60-GT	Casement Outer Frame		6 Pcs with Gasket	1.034 Kg/Mtr	
CSO-60-GT	Casement Window Sash (Outward)		6 Pcs with Gasket	1.217 Kg/Mtr	
CSI-60-GT	Casement Window Sash (Inward)		6 Pcs with Gasket	1.067 Kg/Mtr	
CFTM-60-GT	T-Mullion		6 Pcs with Gasket	1.067 Kg/Mtr	
CFZM-60-GT	Z-Mullion		6 Pcs with Gasket	1.067 Kg/Mtr	
CDSO-104-GT	Casement Door Sash (Outward)		4 Pcs with Gasket	1.597 Kg/Mtr	

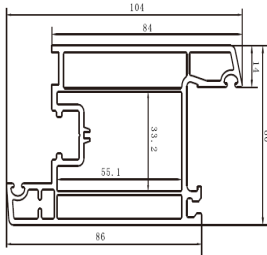
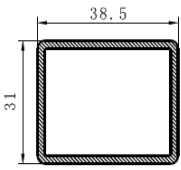
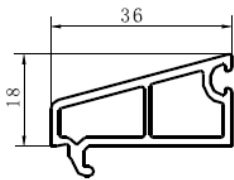
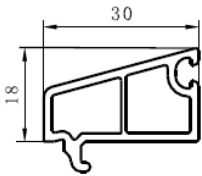
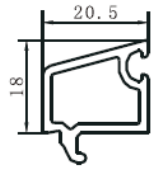
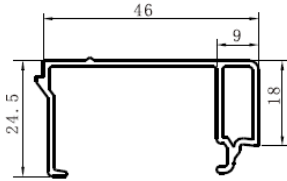
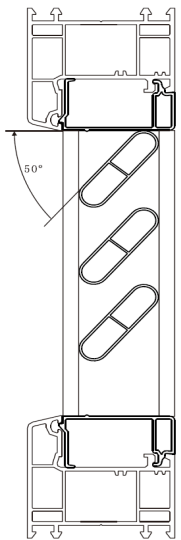
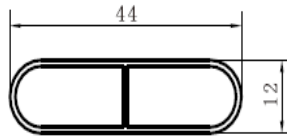
Profile Code	Name & Details	Profile Sectional View	Pack Qty	Wt/Mtr	Steel
CDSI-104-GT	Casement Door Sash (Inward)		4 Pcs with Gasket	1.507 Kg/Mtr	
GB-36-GT	Casement Single Glazing Bead (4-6mm)		20 Pcs with Gasket	0.314 Kg/Mtr	
GB-30-GT	Casement Double Glazing Bead (10-12mm)		20 Pcs with Gasket	0.304 Kg/Mtr	
GB-20-GT	Casement Double Glazing Bead (19-21mm)		20 Pcs with Gasket	0.234 Kg/Mtr	
CLB-GT	Casement Louver Bead		20 Pcs with Gasket	0.280 Kg/Mtr	
CLS-GT	Casement Louver Sash		20 Pcs with Gasket	0.220 Kg/Mtr	

Profile Code	Name & Details	Profile Sectional View	Pack Qty	Wt/Mtr	Steel
CVW-113-GT	Villa Casement Outer		4 Pcs with Gasket	1.620 Kg/Mtr	
CVM-113-GT	Villa T- Mullion		4 Pcs with Gasket	1.700 Kg/Mtr	
CVMS-GT	Villa Mesh Sash (Inward)		8 Pcs with Gasket	1.210 Kg/Mtr	
CVMSGR-GT	Villa Mesh Sash (Gripper)		30 Pcs with Gasket	0.130 Kg/Mtr	
CVMSGB-GT	Villa Mesh Sash (Glazing Bead)		30 Pcs with Gasket	0.090 Kg/Mtr	



The most reasonable way to enjoy wide view

SLIDING WINDOW

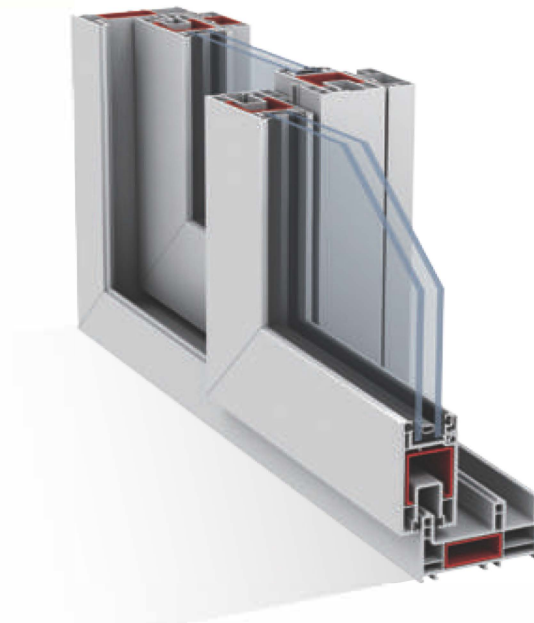

Application | For residential APT

Glass | 4~18mm (Up to 22mm with in use of silicon)
Number of chamber | 3 chamber

Fix+Slide system



Raised water block

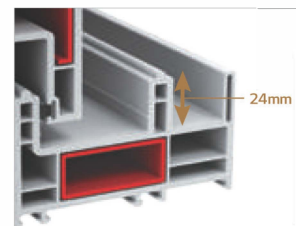

Smooth opening system



FEATURES

- **Coupling System**
 - Solved rough and dull shape problem with innovative Fix-Sliding system
- **Smooth opening**
 - Smooth and quietly opening with rail-integrated structure and heavy load sustainable roller
- **Enhanced water tightness**
 - Raised water block elevation (24mm) to prevent the inflow of rainwater
- **Safety design**
 - Designed to protect collision between sliding windows



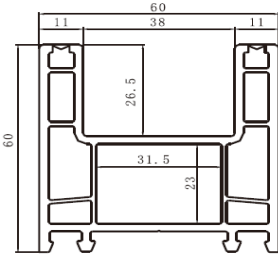
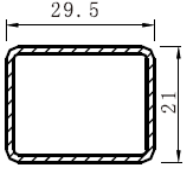
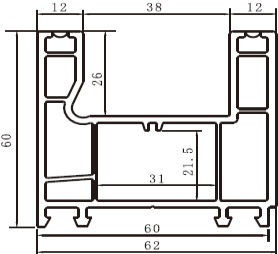
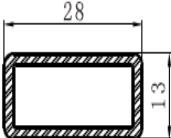
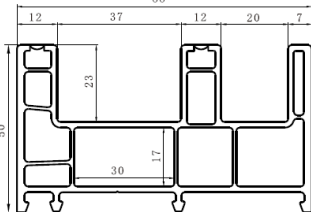
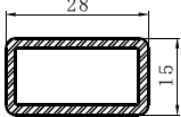
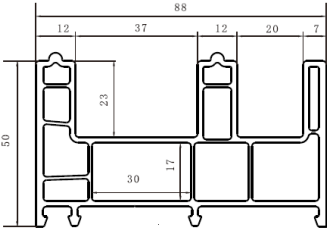
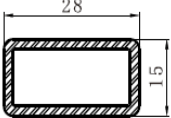
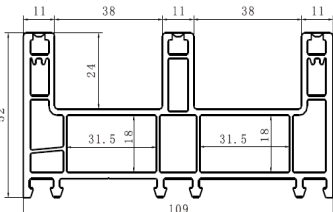
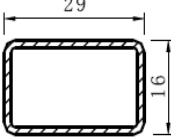
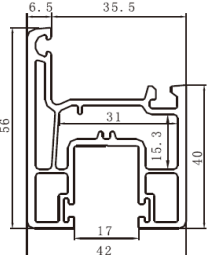
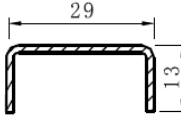

* The more chambers, the insulation performance is better

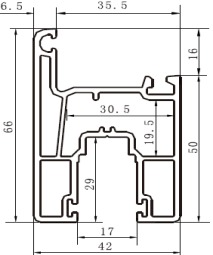
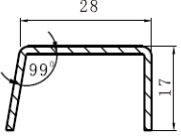
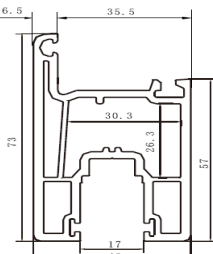
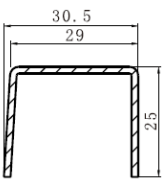
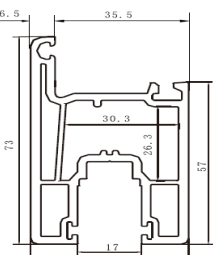
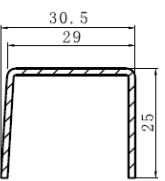
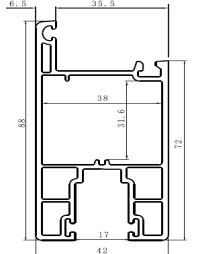
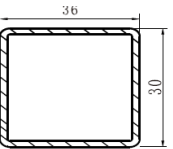
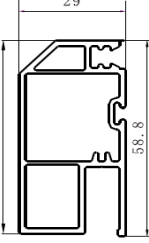
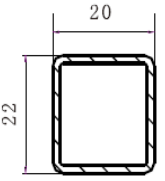
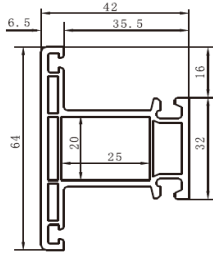
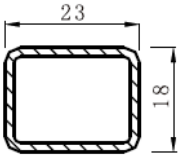
* Some product's handle & locking system can be an option.

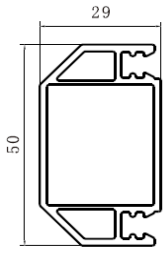
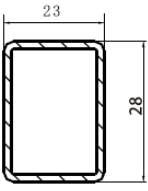
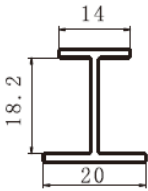
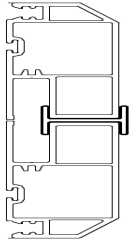
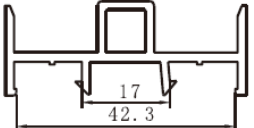
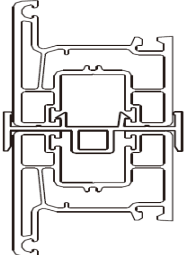
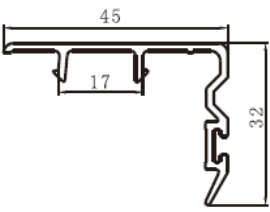
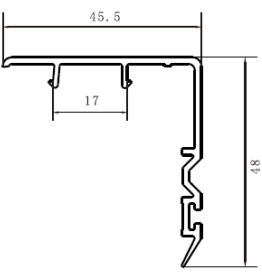
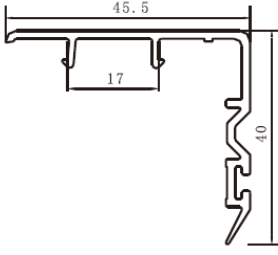
Profile Code	Name & Details	Profile Sectional View	Pack Qty	Wt/Mtr	Steel
BF-60-GT	2 Track Outer Frame		6 Pcs	1.167 Kg/Mtr	
BF-62-GT	2 Track Outer Frame		6 Pcs	1.020 Kg/Mtr	
BF-88-GT	2.5 Track Outer Frame		6 Pcs	1.270 Kg/Mtr	
BF-88WT-GT	2.5 Track Outer Frame with Track (Bump Orbit)		6 Pcs	1.320 Kg/Mtr	
BF-109-GT	3 Track Outer Frame		4 Pcs	1.720 Kg/Mtr	
SF-56-GT	Shutter Frame 56mm (Window Sash)		8 Pcs with Gasket	0.904 Kg/Mtr	

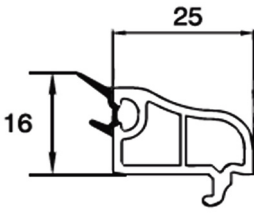
Profile Code	Name & Details	Profile Sectional View	Pack Qty	Wt/Mtr	Steel
SF-66-GT	Shutter Frame 66mm (Window Sash)		8 Pcs with Gasket	1.104 Kg/Mtr	
SF-73-GT	Shutter Frame 73mm (Door Sash)		8 Pcs with Gasket	1.154 Kg/Mtr	
SF-73-GT	Shutter Frame 73mm (Door Sash)		8 Pcs	1.118 Kg/Mtr	
SF-88-GT	Shutter Frame 88mm (Door Sash)		4 Pcs with Gasket	1.194 Kg/Mtr	
MF-58-GT	Mesh Frame		12 Pcs	0.645 Kg/Mtr	
CS-64-GT	Shutter Mullion for SF56/66/73/88		8 Pcs with Gasket	0.787 Kg/Mtr	

Profile Code	Name & Details	Profile Sectional View	Pack Qty	Wt/Mtr	Steel
CS-58-GT	Mesh Mullion		12 Pcs	0.560 Kg/Mtr	
CI-58-GT	Mesh Joint		20 Pcs	0.145 Kg/Mtr	
CI-56-GT	Shutter Joint		10 Pcs	0.340 Kg/Mtr	
MC-36-GT	Interlock for SF56/66/88		20 Pcs	0.270 Kg/Mtr	
MC-88-GT	Interlock for SF-88-GT		20 Pcs	0.320 Kg/Mtr	
MC-73-GT	Interlock for SF-73-GT		20 Pcs	0.290 Kg/Mtr	

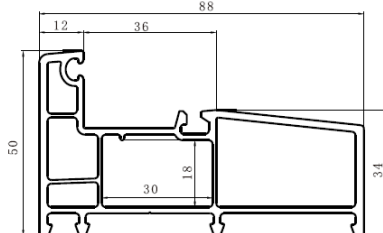
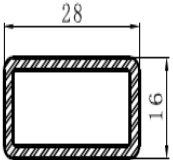
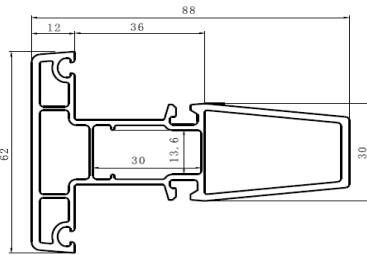
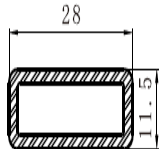
Profile Code	Name & Details	Profile Sectional View	Pack Qty	Wt/Mtr	Steel
GB-25-GT	Sliding Single Glazing Bead (4-6mm)		30 Pcs with Gasket	0.265 Kg/Mtr	
GB-11-GT	Sliding Double Glazing Bead (17-19mm)		40 Pcs with Gasket	0.194 Kg/Mtr	
GB-9-GT	Sliding Double Glazing Bead (19-21mm)		40 Pcs with Gasket	0.194 Kg/Mtr	
GB-7-GT	Sliding Double Glazing Bead (23-25mm)		50 Pcs with Gasket	0.164 Kg/Mtr	
FM-88-GT	Fixed Frame for BF-88		6 Pcs with Gasket	1.064 Kg/Mtr	
FF-88-GT	Mullion for FM-88		6 Pcs with Gasket	1.167 Kg/Mtr	

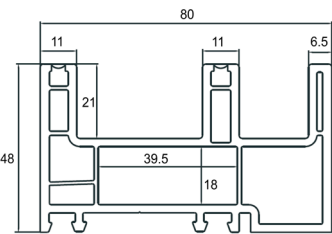
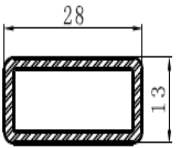
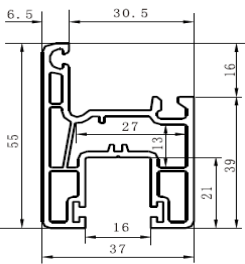
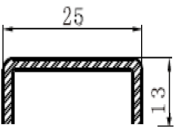
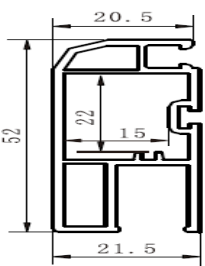
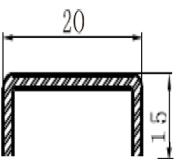
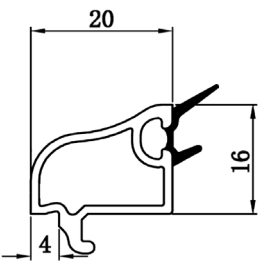
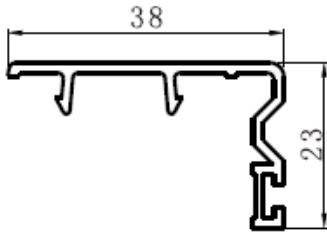
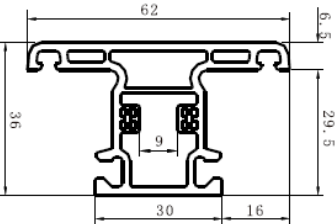
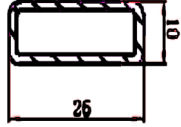
Profile Code	Name & Details	Profile Sectional View	Pack Qty	Wt/Mtr	Steel
BF-80-GT	2.5 Track Outer Frame		6 Pcs	1.100 Kg/Mtr	
SF-55-GT	Shutter Frame 55mm (Window Sash)		12 Pcs with Gasket	0.754 Kg/Mtr	
MF-52-GT	Mesh Frame		16 Pcs	0.500 Kg/Mtr	
GB-20-GT	Sliding Single Glazing Bead (4-6mm)		30 Pcs with Gasket	0.240 Kg/Mtr	
MC-23-GT	Interlock for SF55		20 Pcs	0.170 Kg/Mtr	
CS-62-GT	Shutter Mullion for SF-55		12 Pcs	0.710 Kg/Mtr	

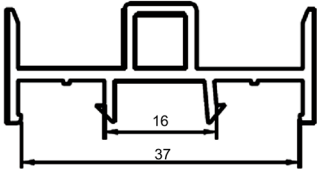
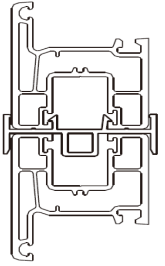
Profile Code	Name & Details	Profile Sectional View	Pack Qty	Wt/Mtr	Steel
CI-37-GT	Shutter Joint		10 Pcs	0.280 Kg/Mtr	



Lamination

As Greentech fabricator-partner, you can offer customers a range of lamination & texture options, including natural wood inish in Golden Oak, Walnut, Dark Oak or Mahogany. Or simply an Asian ivory white.

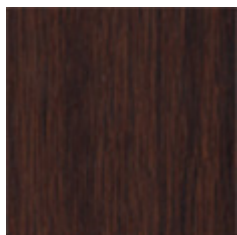

Walnut

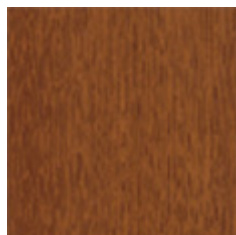

Golden Oak

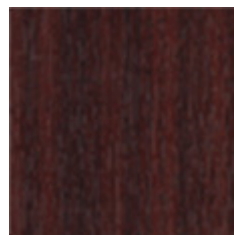

Mahogany

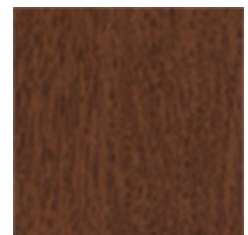

Dark Oak

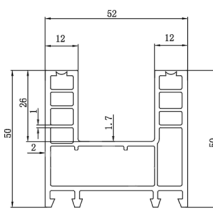
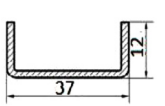
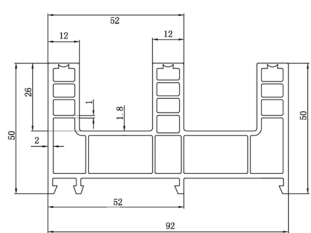
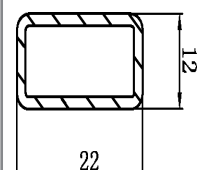
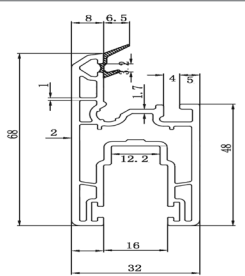
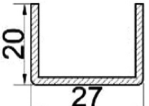
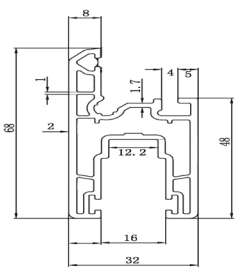
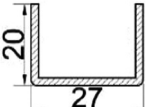
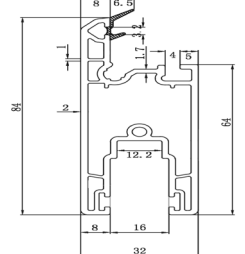
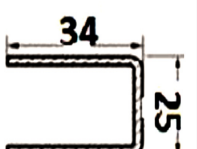
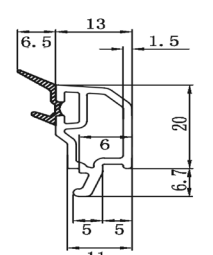

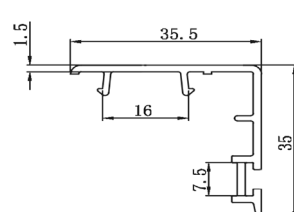
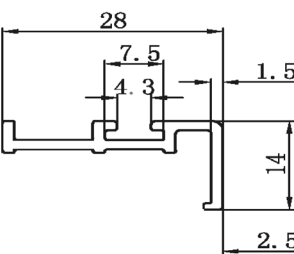
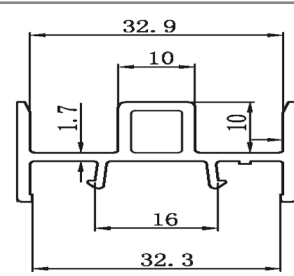
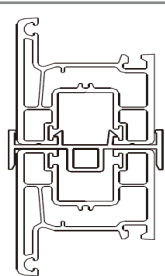
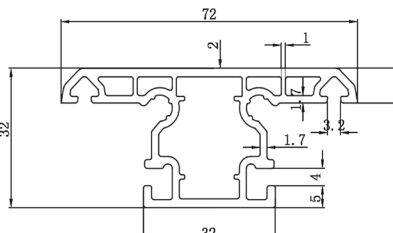
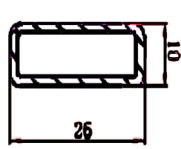
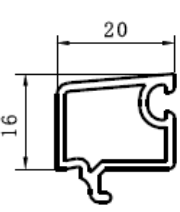
Profile Code	Name & Details	Profile Sectional View	Pack Qty	Wt/Mtr	Steel
BF-52-GT	2 Track Outer Frame		6 Pcs	0.910 Kg/Mtr	
BF-92-GT	3 Track Outer Frame		4 Pcs	1.380 Kg/Mtr	
SF-68-GT	Shutter Frame 68mm (Window Sash)		8 Pcs with Gasket	0.900 Kg/Mtr	
SF-68WR-GT	Shutter Frame 68mm (Window Sash)		8 Pcs	0.870 Kg/Mtr	
SF-84-GT	Shutter Frame 84mm (Door Sash)		8 Pcs with Gasket	1.000 Kg/Mtr	
GBN-25-GT	Sliding Single Glazing Bead (4-6mm)		20 Pcs with Gasket	0.220 Kg/Mtr	

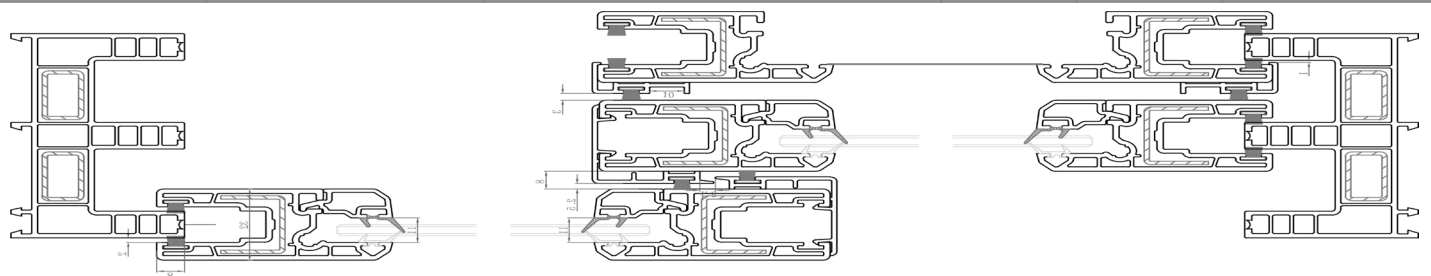
Profile Code	Name & Details	Profile Sectional View	Pack Qty	Wt/Mtr	Steel
MC-35-GT	Interlock for SF68/84		20 Pcs	0.230 Kg/Mtr	
MC-28-GT	Interlock for SF-68WR-GT		20 Pcs	0.130 Kg/Mtr	
CI-32-GT	Shutter Joint		10 Pcs	0.300 Kg/Mtr	
CS-72-GT	Shutter Mullion for SF-68/84		8 Pcs with Gasket	0.760 Kg/Mtr	
GB-1920-GT	Sliding Single Glazing Bead (4-6mm) for SF-68WR-GT		20 Pcs with Gasket	1.000 Kg/Mtr	

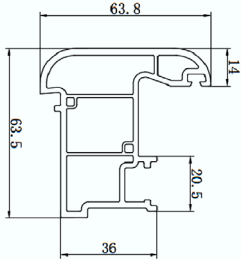
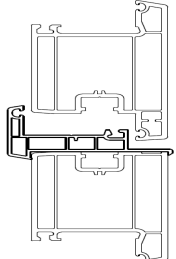
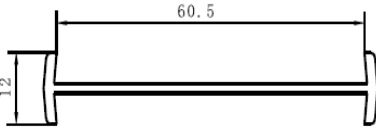
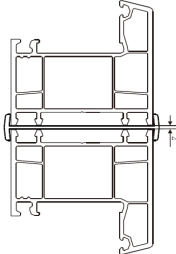
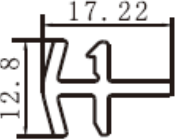
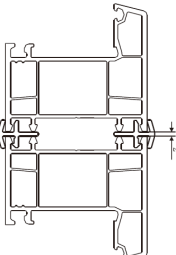
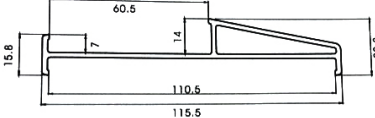
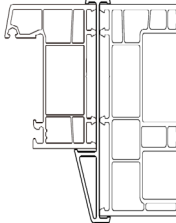
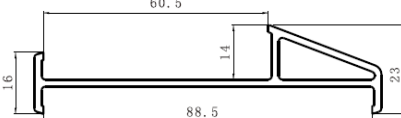
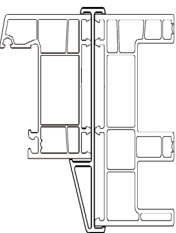
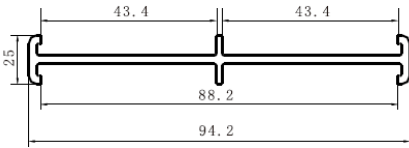
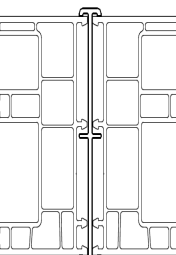

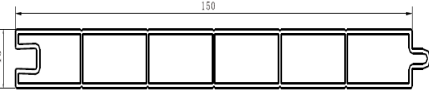
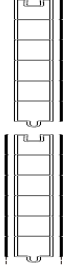
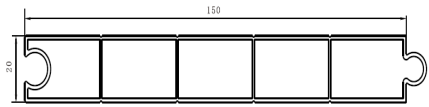
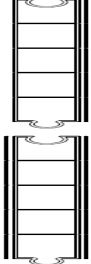
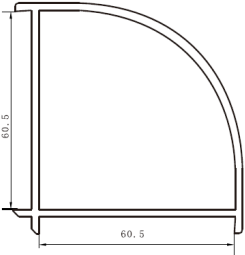
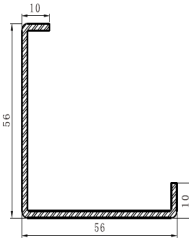
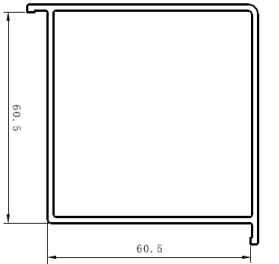
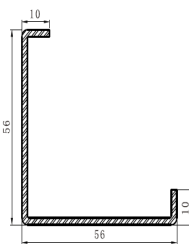
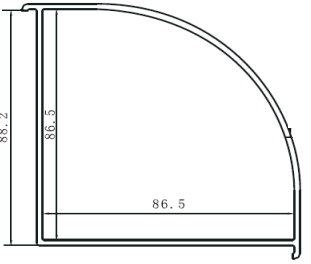
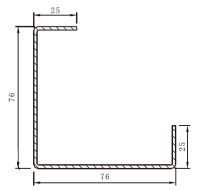
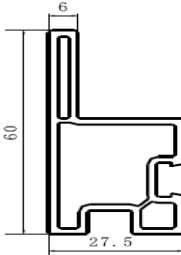
Profile Code	Name & Details	Profile Sectional View	Pack Qty	Wt/Mtr	Steel
CSM-60-GT	Movable Mullion (Float Mullion)		6 Pcs	1.003 Kg/Mtr	
CP-1-GT	Coupling Profile 60 Full		20 Pcs	0.200 Kg/Mtr	
CP-2-GT	Fixed Coupler		40 Pcs	0.110 Kg/Mtr	
CP-3-GT	Coupling Profile 60-109		20 Pcs	0.600 Kg/Mtr	
CP-4-GT	Coupling Profile 60-88		20 Pcs	0.500 Kg/Mtr	
CP-88-GT	Coupling for BF- 88-GT		20 Pcs	0.500 Kg/Mtr	

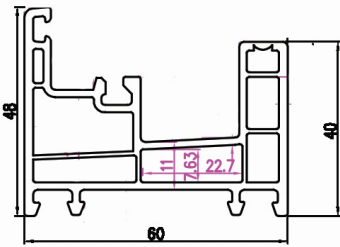
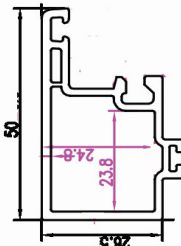
Profile Code	Name & Details	Profile Sectional View	Pack Qty	Wt/Mtr	Steel
DP-15-GT	15mm Door Pannel		6 Pcs	0.640 Kg/Mtr	
DP-20-GT	20mm Door Pannel		6 Pcs	0.770 Kg/Mtr	
CPR-60-GT	Corner Profile Round CF 60 GT		4 Pcs	0.750 Kg/Mtr	
CPS-60-GT	Corner Profile Square CF 60 GT		4 Pcs	0.720 Kg/Mtr	
BP-88-GT	Baypoll - BF 88		4 Pcs	1.040 Kg/Mtr	
MF-60-GT	Add on Track		8 Pcs	0.600 Kg/Mtr	

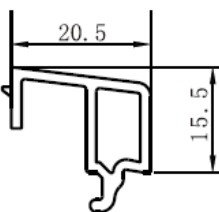
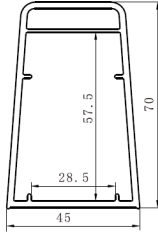
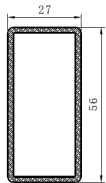
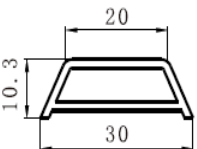
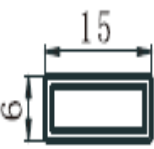
Profile Code	Name & Details	Profile Sectional View	Pack Qty	Wt/Mtr	Steel
MR-60-GT	Mono Rail		6 Pcs	0.960 Kg/Mtr	
M-60-GT	Mullion for MR-60-GT		8 Pcs	0.550 Kg/Mtr	
GB-9-GT	Sliding Glazing Bead		40 Pcs with Gasket	0.194 Kg/Mtr	
LB-20-GT	Louver Glazing Bead		40 Pcs	0.170 Kg/Mtr	
HR-70-GT	Hurricane Bar		6 Pcs	0.851 Kg/Mtr	
Bar-GT	Gorgean Bar	 20 Pcs	 100 Pcs	0.200 Kg/Mtr	0.084 Kg/Mtr

HEAD OFFICE

GREENTECH UPVC INDIA PVT LTD

Survey No.220&223, Sampanbole Village,
Jaganguda G.P., Shamirpet Mandal,
Medchal-Malkajgiri -District,
Hyderabad, Telangana-500078.

Cell: +91 77021 68563

Email Id: greentechupvcindia14@gmail.com



BRANCHES

BANGALORE

Survry.No.67, Agrahara Layout,
Kogilu Cross Road, Yelahanka,
Bangalore, Karnataka-560064.

Cell: +91 88929 78078

Email Id:greentechupvcbangaluru21@gmail.com

GUNTUR

255/B, Suryadeva Raghupathirao
Estate, Etukuru Road Bypass,
Guntur, Andhra Pradesh-522005.

Cell: +91 93904 95075

Email Id:greentechupvcindia14@gmail.com

VISAKHAPATNAM

90/1 D-Block,
Auto Nagar, Gajuwaka
Visakhapatnam, AndhraPradesh-530012.

Cell: +91 93904 95075

Email Id:greentechupvcindia14@gmail.com

CHENNAI

88/1 & 88/2, Perumal Koil Street,
Kolappancheri, Thiruvallur,
Chennai, Tamilnadu-600072.

Cell: +91 89772 38563

Email Id:greentechupvcchennai22@gmail.com

COIMBATORE

183/4 & 183/5, Arasur Road,
Muthalipalayam, Neelambur,
Coimbatore, Tamilnadu-641407.

Cell: +91 81484 58563, 81484 68563

Email Id:coimbatoregreentech@gmail.com

GHAZIABAD

C-35, Industrial Area Ghaziabad,
Meerut Road,
Ghaziabad, Uttar Pradesh-201003.

Cell: +91 95400 65007, 78383 08563

Email Id:greentechupvcghaziabad@gmail.com

www.greentechupvc.com
